

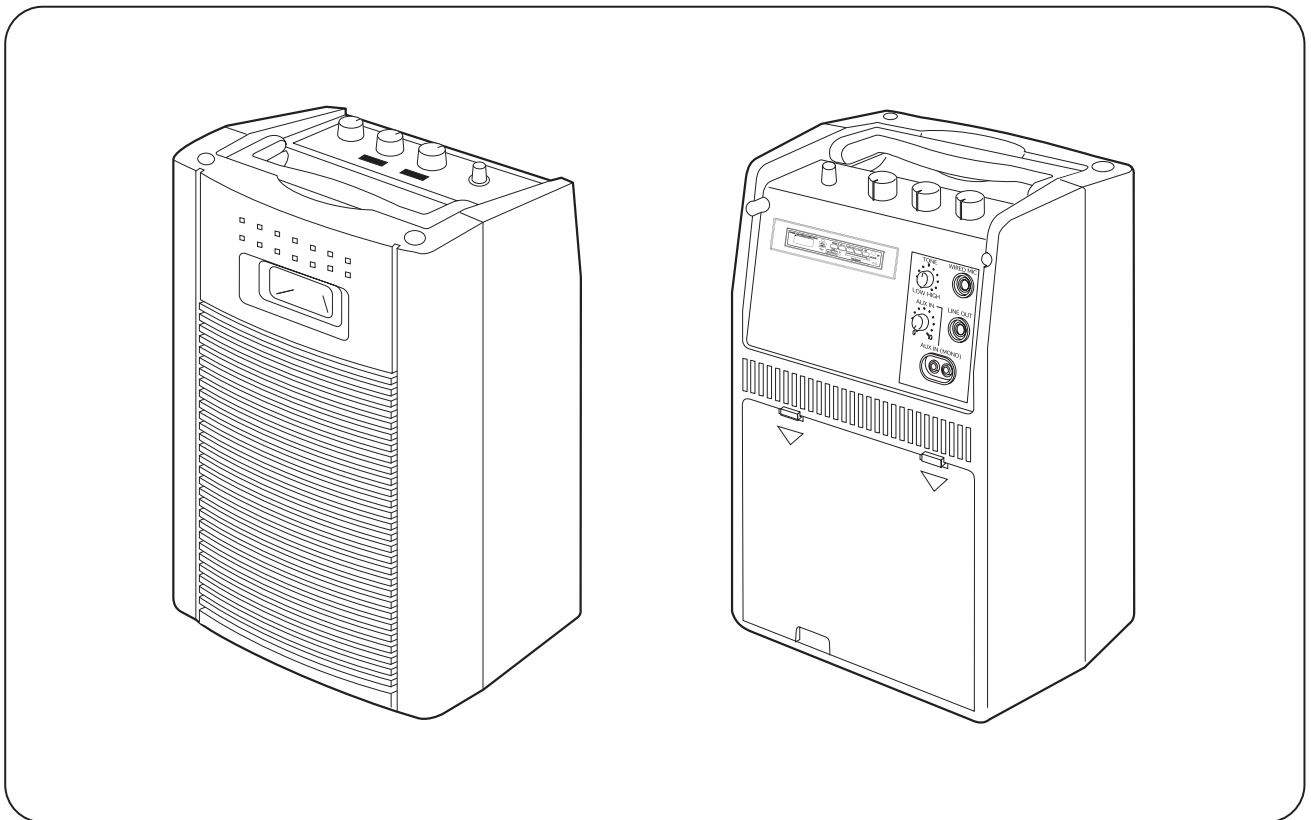

INSTRUCTION MANUAL

WIRELESS MEETING AMPLIFIER

WA-1830M-AS
WA-1830MB-AS



Thank you for purchasing TOA's WA-1830M-AS and WA-1830MB-AS Wireless Meeting Amplifier.
Please carefully follow the instructions in this manual to ensure long, trouble-free use of your equipment.

TOA Corporation

TABLE OF CONTENTS

1. SAFETY PRECAUTIONS	3
2. GENERAL DESCRIPTION	4
3. FEATURES	4
4. HINTS FOR BETTER USE	5
5. NOMENCLATURE AND FUNCTIONS	5
6. ABOUT THE OPERATING MP3	9
7. ABOUT THE POWER SOURCE	10
7.1. Using AC Power Supply	10
7.2. Using Battery	11
7.2.1. Battery Type	11
7.2.2. Battery Installation (Remove)	11
7.2.3. Install New Battery (WA-1830M-AS only)	11
7.2.4. Power Supply Switching	11
7.2.5. Guide Lines on Battery Recharge Times	11
8. USING A WIRED MICROPHONE	12
9. USING A WIRELESS MICROPHONE	12
9.1. Tuner Unit Installation	13
9.2. Frequency Setting	13
10. ABOUT EXTERNAL EQUIPMENT	13
10.1. When Using External Speakers	13
10.2. When Using an External CD Player	14
10.3. When Using an External Amplifier	15
11. TROUBLESHOOTING	15
12. SPECIFICATIONS	16

1. SAFETY PRECAUTIONS

- Be sure to read the instructions in this section carefully before use.
- Make sure to observe the instructions in this manual as the conventions of safety symbols and messages regarded as very important precautions are included.
- We also recommend you keep this instruction manual handy for future reference.



WARNING

Indicates a potentially hazardous situation which, if mishandled, could result in death or serious personal injury.

- **Warning:** To reduce the risk of fire or electric shock, do not expose this apparatus to rain or moisture. Do not place objects filled with liquids such as vases on the apparatus.

When Installing the Unit

- Use the unit only with the voltage specified on the unit. Using a voltage higher than that which is specified may result in fire or electric shock.
- Do not cut, kink, otherwise damage nor modify the power supply cord. In addition, avoid using the power cord in close proximity to heaters, and never place heavy objects -- including the unit itself -- on the power cord, as doing so may result in fire or electric shock.
- Avoid installing or mounting the unit in unstable locations, such as on a rickety table or a slanted surface. Doing so may result in the unit falling down and causing personal injury and/or property damage.
- To prevent lightning strikes, install the unit at least five meters away from a lightning rod, and yet within the protective range (angle of 45°) of the lightning conductor. Lightning strikes may cause a fire, electric shock or personal injury.

When the Unit is in Use

- Should the following irregularity be found during use, immediately switch off the power, disconnect the power supply plug from the AC outlet and contact your nearest TOA dealer. Make no further attempt to operate the unit in this condition as this may cause fire or electric shock.
 - If you detect smoke or a strange smell coming from the unit.
 - If water or any metallic object gets into the unit
 - If the unit falls, or the unit case breaks
 - If the power supply cord is damaged (exposure of the core, disconnection, etc.)
- Do not insert nor drop metallic objects or flammable materials in the ventilation slots of the unit's cover, or the MP3 player, as this may result in fire or electric shock.
- Do not touch a plug during thunder and lightning, as this may result in electric shock.
- To prevent a fire or electric shock, never open nor remove the unit case as there are high voltage components inside the unit. In addition, modifying the internal parts or circuit may cause the unit to be against the regulations in your country.
Refer all servicing to your nearest TOA dealer.



CAUTION

Indicates a potentially hazardous situation which, if mishandled, could result in moderate or minor personal injury, and/or property damage.

When Installing the Unit

- Never plug in nor remove the power supply plug with wet hands, as doing so may cause electric shock.
- When unplugging the power supply cord, be sure to grasp the power supply plug, never pull on the cord itself. Operating the unit with a damaged power supply cord may cause a fire or electric shock.

- When moving the unit, be sure to remove its power supply cord from the wall outlet. Moving the unit with the power cord connected to the outlet may cause damage to the power cord, resulting in fire or electric shock. When removing the power cord, be sure to hold its plug to pull.
- Avoid installing the unit in humid or dusty locations, in locations exposed to the direct sunlight, near the heaters, or in locations generating sooty smoke or steam as doing otherwise may result in fire or electric shock.
- The socket-outlet shall be installed near the equipment and the plug (disconnecting device) shall be easily accessible.

When the Unit is in Use

- Do not place heavy objects on the unit as this may cause it to fall or break which may result in personal injury and/or property damage. In addition, the object itself may fall off and cause injury and/or damage.
- Do not stand or sit on, nor hang down from the unit as this may cause it to fall down or drop, resulting in personal injury and/or property damage.
- When the unit is not in use for 10 days or more, or when the AC power is used for operating the unit, be sure to take the battery out of the unit because battery leakage may cause a fire, personal injury, or contamination of environment.
- Switch off the power, and unplug the power supply plug from the AC outlet for safety purposes when cleaning or leaving the unit unused for 10 days or more. Doing otherwise may cause a fire or electric shock.
 - Do not short, disassemble, heat nor put the battery into a fire.
 - Do not solder a battery directly.
 - Be sure to use the specified type of battery.
 - Note correct polarity (positive and negative orientation) when inserting a battery in the unit.
 - Avoid locations exposed to the direct sunlight, high temperature and high humidity when storing battery.

2. GENERAL DESCRIPTION

TOA's WA-1830M-AS and WA-1830MB-AS are portable meeting amplifiers featuring 2-way speaker system. It is equipped with a digital amplifier of rated output 30W. WA-1830M-AS has a MP3 player unit and WA-1830MB-AS has a MP3 player unit and Lead Acid battery. Both models can accommodate 2 diversity wireless tuner units of crystal-controlled PLL synthesizer system WTU-4800.

3. FEATURES

- **Excellent Sound Quality**
Both the built-in cone speaker and constant directivity speaker feature the highest sound quality.
- **High Intelligibility**
New circuitry has been designed to reduce sound distortion at high-volume sound outputs to realize excellent intelligibility for both quiet and loud sounds.
- **High Power and Long Battery Life**
Although rated at a high power output of 30 W, the WA-1830M-AS and WA-1830MB-AS consumes low power to maintain a longer battery life.
- **Lightweight Design**
Carefully reviewed design and construction realize reduced and balanced weight that facilitates transport and makes the Meeting Amplifier seem lighter than it actually is.
- **Improved Operating Ease**
 - Knobs are easy to operate, and indications are larger and more legible.
 - Increased component storage volume is large enough to accommodate 2 wireless microphones, 1 wired microphone and a dust cover.
 - Design battery compartment to easy replacement battery with the new one.
 - Snap-in type external speaker terminal facilitates external speaker connection.

4. HINTS FOR BETTER USE

- **Positioning Orientation**

Position the unit with its front (speaker side) oriented toward the listeners to avoid feedback. If feedback occurs, move the microphone away from the unit or decrease the output volume.

- **Location**

Sound from the speaker can be heard more clearly by positioning the unit above floor level, such as on a desk. The distance between the meeting amplifier and the wireless microphone can also be made longer.

- **Dead Point**

As the wireless microphone user moves, a point where signal reception is abruptly and temporarily lost may be encountered due to radio signal reflection or interference. To avoid such a dead point, keep the unit away from walls or desks, or move the unit location approximately 1 – 2 m in any direction.

- **Radio Signal Source Interference**

Keep the unit away from fluorescent lamps or computers, which can generate high frequency noise, as radio interference could result, shortening the wireless microphone's transmission distance.

- **Wireless Microphone Distance**

Keep the unit at least 3 m away from the wireless microphone. If the distance is shorter than 3 m, feedback noise can be generated, resulting in radio interference.

- **Cleaning**

When cleaning, be sure to switch off the power, then wipe with a dry cloth. If the unit should become extremely dirty over time, use a cloth dampened in a neutral detergent. Never use volatile liquids such as benzene or thinner, because they can deform or discolor the unit's case.

5. NOMENCLATURE AND FUNCTIONS

[Front]

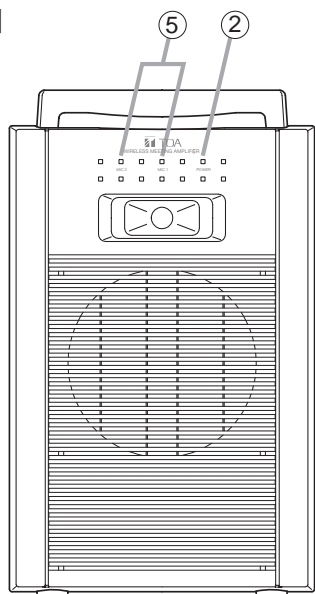

[Top]

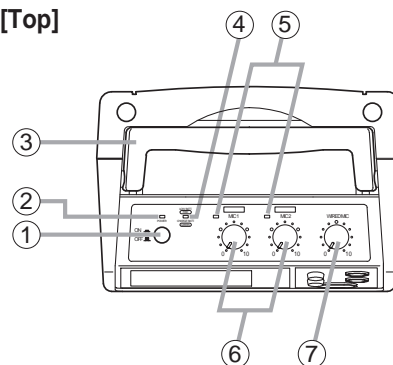

[Rear]

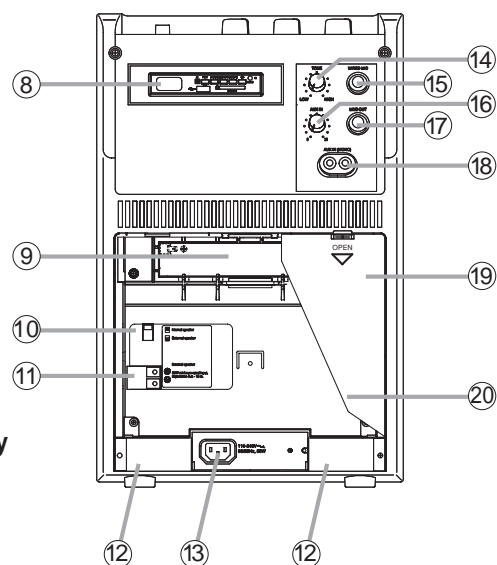

[Tuner Cover]

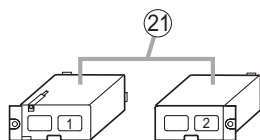

To be mounted to the Wireless tuner receptacle (12)

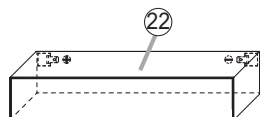

[Battery Unit] WA-1830MB-AS does not include battery

To be installed in the battery compartment (9)



1. **Power switch**
Turns the power ON and OFF when pressed.
2. **Power Indicator**
Lights green when the power switch is set to the ON position.
3. **Handle**
Raise and use this handle to carry the unit.
Note: Use this handle only to transport the unit.
Never suspend the unit from this handle.
4. **Low Battery Indicator / Charge Battery**
The indicator light turns red when the battery is low and the indicator light turns green when battery under charging. No light indicates when battery full charge.
5. **Wireless Indicator LED**
The light is orange when the unit receives the radio signal from the wireless microphone.
6. **Wireless Microphone Volume Control**
As a general guide line. Set this control to position 3 for clip-on wireless microphone and position 7 of hand-held wireless microphone. These position are marked with larger dot marking.
7. **Wired Microphone Volume Control**
Adjust the volume of the microphone connected to the microphone input terminal. As a general rule of thumb, set this control to position 5 (the larger dot).
8. **MP3 Player Unit**
Details of operation described are on p.9 of this manual.
9. **Battery Compartment**
Holds the unit's cartridge-type battery case.
10. **Internal or External Speaker Switch Selection**
 -  : Enables internal speaker only.
 -  : Enables external speaker only.
11. **External Speaker Terminal**
Connect an 4 – 16 Ω speaker rated for at least 30 W to this terminal. Note the correct polarities when connecting.
12. **Wireless Tuner Receptacle**
Has 2 (optional) wireless tuners can be installed.
13. **AC inlet**
Connect the supplied AC power cord to this inlet.
14. **Tone Control**
Rotate clockwise to accentuate high frequency sounds, and counterclockwise to accentuate low frequency sounds.
15. **Wired Microphone Terminal**
Connect a wired microphone here. (Applicable microphone: 600 Ω , -45 dB*, unbalanced, 6.3 mm phone jack)
16. **External input Volume Control**
Adjusts the sound volume of connected external equipment.
17. **External Output Terminal**
Connect an external Wireless Meeting Amplifier or amplifier to this terminal. (1 k Ω , 0 dB*, Unbalanced, 6.3 mm phone jack)
18. **External input Terminal**
Enables connection to a CD player or other sound source. Pin jack x 2 (monaural) (10 k Ω , -20 dB*, unbalanced type)
19. **Compartment Cover**
20. **Component Compartment**
Used to store such components as the power cord, wired and wireless microphones, and dust cover.
21. **Tuner Cover**
This cover must be attached after installing the tuner.
22. **Battery Unit (WA-1830M-AS does not include battery)**
Details of using batteries are described on p.11 of this manual.

* 0 dB = 1 V

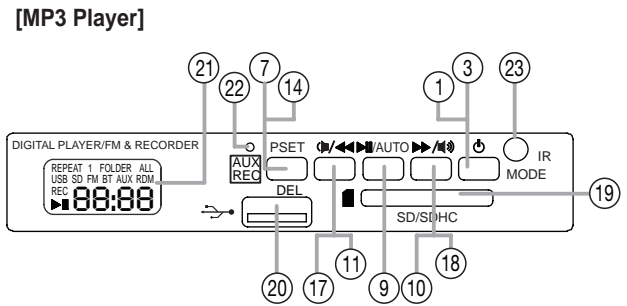
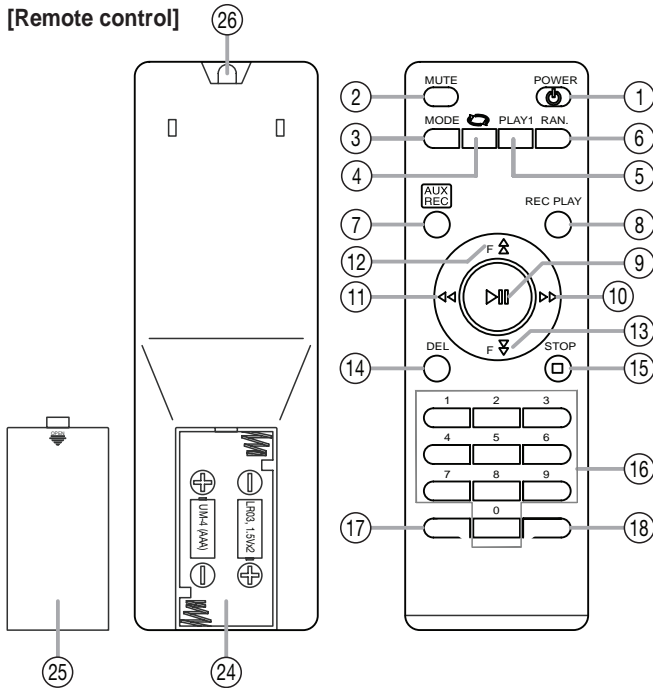

1. POWER

When the unit is turned ON, pressing this button for 3 seconds will turn off the unit. When the unit is turned OFF, pressing this button will turn on the unit. Display will play to the last mode.

2. MUTE

In MP3 mode, pressing this button will mute the sound. Press again, sound will appear. Display Text " U-00 " will appear and blinking.

3. MODE

When the unit is turned ON, pressing this button will switch between the modes. Display text will appear "AUX → FM → USB → SD → BT".

4. (REPEAT)

While playing, pressing this button will switch between : "REPEAT ALL → REPEAT FOLDER → REPEAT 1 → PLAY ALL".

5. PLAY 1

While playing, pressing this button will play 1 track then stop. Display text appear " -1- ", then " ►► ", and display time blinking.

6. RAN.

In MP3 mode, pressing this button enter the random mode of track. Display text appear " RDM ", pressing again text will disappear.

7. AUX REC

In Aux mode, pressing this button will record to SD card. If SD card is not inserted to the slot, the unit will record to the inserted USB. If pressing this button while recording, the unit will stop recording, and the track that was being recored will be saved in the last space of the folder. LED

is turned ON when the Record begins and will OFF when the record ends (on Panel MP3). Display text appear " REC " and time. In FM mode, pressing this button enter the station saving mode. Then, press ►► play to save the current frequency as a station or press F▲ or F▼ folder on the remote control to choose position for saved frequency. Then press this button for 3 seconds to actually save this frequency to this position. Display text appear " SAVE ".

8. REC PLAY

In MP3 mode, Pressing this button will enter record folder and play the latest recording.

9. ►► (PLAY/PAUSE)

In MP3 mode, pressing this button, PLAY will switch to PAUSE. Pressing again PAUSE will switch to PLAY. Display ►► will appear, and time indicator blinking. If the unit has been STOPPED, it will switch to PLAY. In FM mode, pressing this button will skip to the Channel Frequency has been saved.

In FM mode, pressing this button for 3 seconds will automatically search and save available station in a maximum number of 30 station. Display CH01, CH02, ...CH30.















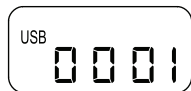

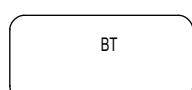



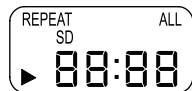
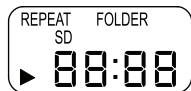
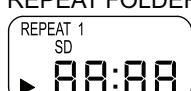
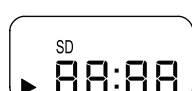



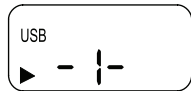
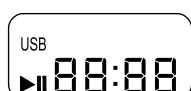



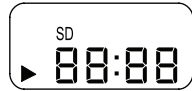
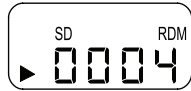

10. ►► (Skip +)

In MP3 mode, pressing this button will skip to the next track, keeping pressing this button will fast-forward (function only remote).

In FM mode, pressing this button will tune upwards in frequency with each segment of 50 kHz. Pressing this button for 3 seconds will search stations upwards in frequency and the search will automatically stop at the frequency where there is station available.

- 11. ⏮ (Skip -)**
 In MP3 mode, pressing this button will skip to the last track, keeping pressing this button will fast-rewind (function only remote).
 In FM mode, pressing this button will tune downwards in frequency with each segment of 50 kHz.
 Pressing this button for 3 seconds will search stations downwards in frequency and the search will automatically stop at the frequency where there is station available.
- 12. F ▲ (Folder +)**
 In MP3 mode, pressing this button enters the next folder. In FM mode, pressing this button enters the next saved station.
- 13. F ▼ (Folder -)**
 In MP3 mode, pressing this button enters the last folder. In FM mode, pressing this button enters the last saved station.
- 14. DEL**
 In MP3 mode, pressing this button to choose the track that the user wants to delete and then pressing it for 3 seconds to actually delete the track. Text appear "DEL"
- 15. STOP**
 In PLAY/PAUSE mode and if pressing this button, the unit will STOP. Pressing STOP once will stop at the currently played track. Pressing STOP twice will stop at the first track.
- 16. 0-9**
 Number buttons, 0-9 for MP3 mode. Track number blinking. Quantity number track until 9999. In FM mode, pressing this button will arouse (call out) saved station. Pressing this button for 3 seconds will save the station frequency radio.
- 17. 🔊 (Decrease)**
 Keep pressing this button will decrease the Volume (Display U32 → U00).
- 18. 🔊 (Increase)**
 Keep pressing this button will increase the Volume (Display U00 → U32).
- 19. SD Card Input**
 For input SD card.
- 20. USB Card Input**
 For input USB.
Note : - Not recommended for charging.
- 21. Display Indicators**
 Indicator 188:88: This indicator illuminates by counting / increasing when operating the MP3 player.
 . For volume displayed (U-00 → U-32) with +/- 1.
 . For FM Radio in increase - decrease vol mode is displayed (87.50 → 108.00) with +/- 50 kHz.
 . For FM Radio in play pause mode can be saved and displayed (CH01 → CH30)
 USB indicator: when connected this indicator lights up with blinking on the display, file is ready to operate.
 SD indicator: when connected this indicator flashes with blinking on the display, file is ready to operate.
 FM indicator: when FM mode is selected or when it is turned on this indicator lights up with blinking on the display.
 BT Indicator: when connected/ pairing this indicator lights up with blinking on the display, file is ready to operate.
 ▶ Play indicator: in MP3 mode is illuminated with blinking on the display, indicating it is operating PLAY.
 ▶|| Pause indicator: in MP3 mode is illuminated with blinking on the display, indicating it is operating PAUSE.
 AUX indicator: when AUX mode is selected input from AUX, Wire Mic, Wireless Mic connects to MP3.
 REC indicator: when AUX mode is selected then pressing PSET then start REC Record and display illuminated with blinking and the result is saved to USB or SD Card, if USB or SD Card is installed.
- 22. AUX REC Indication**
 Turns on when turning Record results.
- 23. IR Receiver**
 For signal receiver from remote control.
- 24. Remote Battery Case**
 Insert 2 LRO 1.5V or UM-4 (AAA size) batteries, note correct polarity (positive and negative orientation) when inserting a battery.
- 25. Remote Cover**
 This cover must be attached after installing the batteries.
- 26. IR Transmitter**

6. ABOUT THE OPERATING MP3

Remote	MP3 Player	Operating Mode	Indication
		- Press button MODE while USB & SD install "AUX→FM→USB→SD→BT".	a. USB & SD install 1.  Display mode AUX → 2.  Display mode FM ↓ 3.  Display mode USB ↓ 4.  Display mode SD 5.  Display mode Bluetooth
		- Press button  " REPEAT ALL → REPEAT FOLDER → REPEAT 1 → PLAY ALL ". (Operates on MODE "SD and USB" or MP3 Mode).	SD install 1.  Display REPEAT ALL → 2.  Display REPEAT FOLDER ↓ 3.  Display REPEAT 1 4.  Display PLAY ALL
		* MP3 Mode (USB or SD) - Press button PLAY1. - Will stop after a track is finish. - Press button  again will play to next track. - Press button PLAY1 again will normal play.	USB install 1.  Display normal play → 2.  Display PLAY1 ↓ 3.  Display STOP 4.  Display next track
		* MP3 Mode (USB or SD) - Playing normal condition. - Press button RAN. (Operates on a new track random conditions) - Press button RAN. again will normal play.	SD install 1.  Display normal play → 2.  Display change track Random
		* MP3 Mode (USB or SD) - Playing normal condition. - Press button  will pause. - Press button  again will normal play.	USB install 1.  Display normal play → 2.  Display blinking
		* FM Mode - Playing normal condition. - Press button  will change next channel.	FM Mode 1.  Display normal play → 2.  Change next channel
		- Press the button 3 seconds will automatically search and save channel from CH01 until CH30 after completion will play in CH01.	FM Mode 1.  Display normal play → 2. 

Remote	MP3 Player	Operating Mode	Indication
			<p>Search and save from CH02 ↓</p> <p>4. Beginning play in CH01 ←</p> <p>3. Until CH30 ↓</p>
	PSET	<p>* MP3 Mode (USB or SD)</p> <ul style="list-style-type: none"> - Press button MODE (display AUX) and then press button AUX REC (will save input from AUX IN, WIRED MIC, WIRELESS MIC at SD as first priority and then USB card and volume control is made Max). - View second will be record Display text appear " rEC " and time. - Press button ► to hold, press again ► will continue to Record. (for prepared recording). - Press button AUX REC again will stop, and will be saved in the last space of the folder. 	<p>AUX Mode and insert SD card</p> <p>1. Display AUX mode →</p> <p>2. Press AUX REC ↓</p> <p>6. Display AUX mode ↑</p> <p>3. Record start at SD ↓</p> <p>5. Record start at SD ← </p> <p>4. Time indication blinking </p>
		<p>* FM Mode</p> <ul style="list-style-type: none"> - Press button AUX REC enter the station saving mode. - Press PLAY to save the current frequency as a station or press F▲ or F▼ on the remote control to choose channel position for saved frequency. - Press button AUX REC for 3 sec to actually save this frequency to this position. 	<p>FM Mode</p> <p>1. Display normal play →</p> <p>2. CH initial frequency ↓</p> <p>FM Mode</p> <p>4. Display normal play ←</p> <p>3. If Select no 9, frequency CH09 same with CH02 ↓</p>
		<p>* MP3 Mode (USB or SD)</p> <ul style="list-style-type: none"> - Press this buttons will enter RECORD folder and play the first tack in it. 	<p>USB install</p> <p>1. Display normal play →</p> <p>2. Play the first tack in it.</p>

7. ABOUT THE POWER SOURCE

The WA-1830 Series Wireless Meeting Amplifier is designed to operate on both home-use AC power and specified rechargeable battery.

7.1. Using AC Power Supply

Remove the power cord from the component compartment, and connect to a standard AC outlet. Always be sure the unit's power is switched OFF before connecting or disconnecting the power cord from the AC outlet.

Notes :

- Approximately 1 W is continually consumed even if the power switch is set to the OFF position.
- When the unit is not used, detach the power cord from the AC outlet.

7.2. Using Battery

7.2.1. Battery Type

Lead Acid Battery 12 V, 2.3 Ah. Reference dimension: 178 (w) x 60 (h) x 34 (d) mm / (7" x 2.36" x 1.33")

Notes:

- Recommended battery type : Yuasa NP2.3 -12.
- Factory never tested other type of battery. We can not guarantee other type of recommended battery will work properly with the unit.

7.2.2. Battery Installation (Remove)

Step 1. Be sure to turn the power switch OFF and detach the power cord from the AC outlet.

Step 2. Remove the compartment cover, attach the ribbon upwards and then attach the battery to the outside polarity. Connect the cables according to the polarity of the red (+) and black (-) battery.

Step 3. And then reinsert it in.

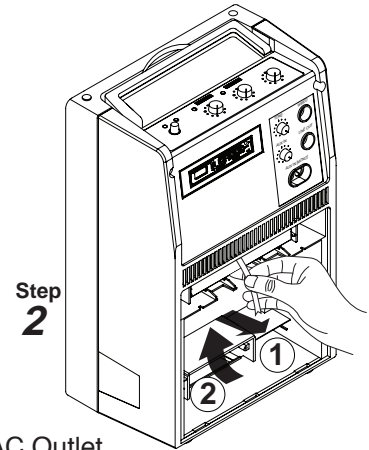

7.2.3. Install New Battery (WA-1830M-AS only)

Step 1. Be sure to turn off the power switch and detach the power cord front AC Outlet

Step 2. Remove the compartment cover, pull the ribbon ties to the unit, install battery type battery lead acid 12 V, 2.3 Ah, Red cable in battery (+) and black cable in battery (-).

Notes:

- Make sure the battery pin faston matches the specification (NT-5A).
- Make sure the battery is not damaged and the liquid does not Leak.
- When the first usage is charging for approximately 10 hours.
- The battery supplied is not a service part and there is no warranty.

Step 3. The longest ribbon is placed above the battery and the short ribbon is on the bottom side.

Step 4. The battery is directed to the unit, with the slave / faston inside. push it in and click (until it's locked).

Step 5. Tie the ribbon tightly to make it safe from shocks, using the butterfly knot technique.

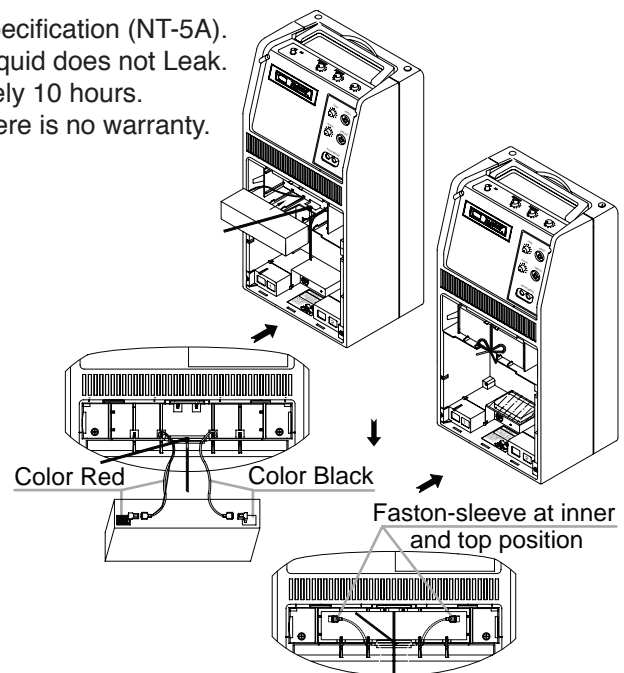

7.2.4. Power Supply Switching

Detaching the power cord from the AC outlet automatically switches the power source from AC to the battery.

7.2.5. Guide Lines on Battery Recharge Times

- A low battery indicator with light (red) indicates that the battery are beginning to lose their charge and should be connect AC inlet as early as possible.
- Intermittent sound output may occur even when the power indicator remains steadily lit. It is recommended that the battery be recharge as early as possible in this case, too.
- Approximate battery usage times (recharge times) are shown below.

[When using the WA-1830 at room temperatures of 25°C]

Approximately 5 hours continuous with music playback. (Depend on the sound volume)

Note :

- Remove the battery when not in use for prolonged periods of time (10 days or more).

8. USING A WIRED MICROPHONE

- Step 1.** Connect the wired microphone to the Wired Microphone terminal.
- Step 2.** Set the power switch to the ON position.
- Step 3.** Set the Wired Microphone volume control to approximately "5" on the dial.
- Step 4.** Adjust the sound quality using the tone control.

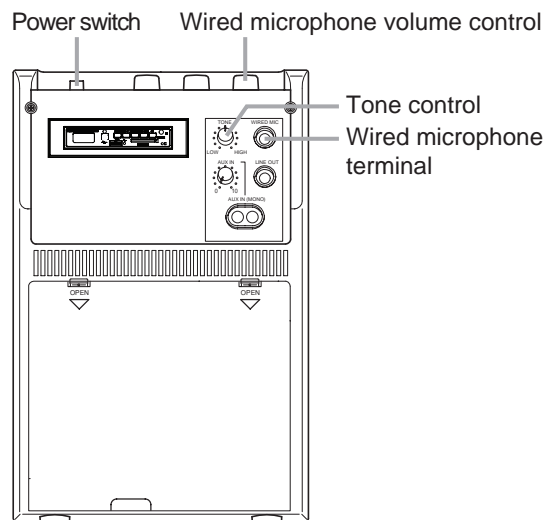

9. USING A WIRELESS MICROPHONE

- Step 1.** Set the power switch to the ON position.
- Step 2.** Set the wireless microphone's power switch to the ON position. (The Radio Signal Reception indicator lamp will light.)
- Step 3.** Adjust the volume by setting the corresponding Wireless Microphone Volume control (either WIRELESS MIC1 or WIRELESS MIC2) to approximately "3" on the dial if a Clip-on wireless microphone is used, or "7" if a hand-held wireless microphone issued.
- Step 4.** Adjust the sound quality using the tone control.

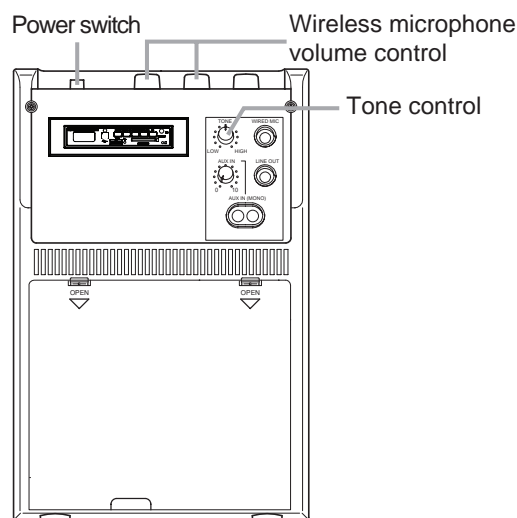

Notes :

- Use only TOA wireless microphones.
- Set the wireless microphone 1 and 2 to different channels from each, otherwise radio interferences.
- Keep the wireless microphone 3 – 20 m away from the Meeting Amplifier.
- If the wireless microphone is positioned less than 3 m from the Meeting Amplifier, feedback noise or radio interference could result.
- When simultaneously using 2 different channels, keep the 2 wireless microphones at least 50 cm away from each other.
- When the Meeting Amplifier's power switch is set to the ON position, if the amplifier's Radio Signal Reception indicator lamp lights before the wireless microphone's power switch is turned ON, this indicates that the currently set channel is in use. In such cases, change the different channel.

9.1. Tuner Unit Installation

The following TOA tuner unit models can be used
WTU-4800 UHF Diversity Tuner Unit

Step 1. Set the power switch to the OFF position.

Step 2. Remove the Compartment cover.

Step 3. Remove the tuner cover located in the lower left or right corner.

Step 4. Fully insert the tuner unit as shown in the accompanying figure until it is securely plugged into the back connector.

Note: Take care not to insert the tuner unit up-side down.

Step 5. Install the tuner cover after mounting the tuner unit.

Note: The tuner unit may become dislodged if the tuner cover is not correctly installed.

Step 6. Tuner unit frequency settings are explained in the previous section Frequency Setting.

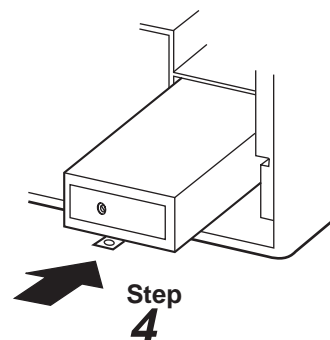
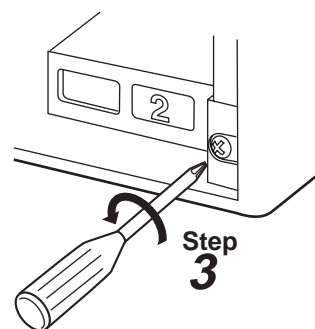

9.2. Frequency Setting

Set different channels as follows when adding a tuner unit or when radio interference occurs during use. Make sure that the amplifier's power switch is set to the OFF position when setting the channel.

Step 1. Select the channel number according to the enclosed frequency table.

Note: Be sure to select different channels when simultaneously using 2 wireless microphones.

Step 2. Using the setting screwdriver provided inside the manual book or the screwdriver supplied with the expansion tuner unit, set the setting switch arrows to the desired channel numbers.

Note: Set the expanded tuner unit to a different channel number.

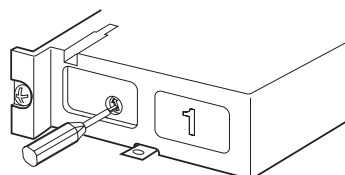
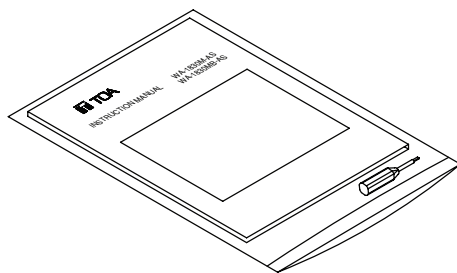

Step 3. Set the wireless microphone to the same channel number as that of the tuner unit.

Note: Using the setting screwdriver supplied with the wireless microphone, set the setting switch arrows to the same channel number as that of the tuner unit. Details are explained in the wireless microphone instruction manual.

10. ABOUT EXTERNAL EQUIPMENT

10.1. When Using External Speaker

[Recommended External Speaker and Stand]

Speaker : A rated input of 30 W or more, and impedance of 4 – 16 Ω.



Stand : Mount the speaker on the TOA ST-16, or other stand.

Notes :

- Note the correct polarities when connecting an external speaker.
- Take care that the External speaker terminals are not shorted during connection.

Step 1. Connect the external speaker to the External speaker terminal.

Step 2. Using the Internal or External speaker switch selection, and select to external speaker only.

-  : Enables the internal speaker only.
-  : Enables the external speaker only.

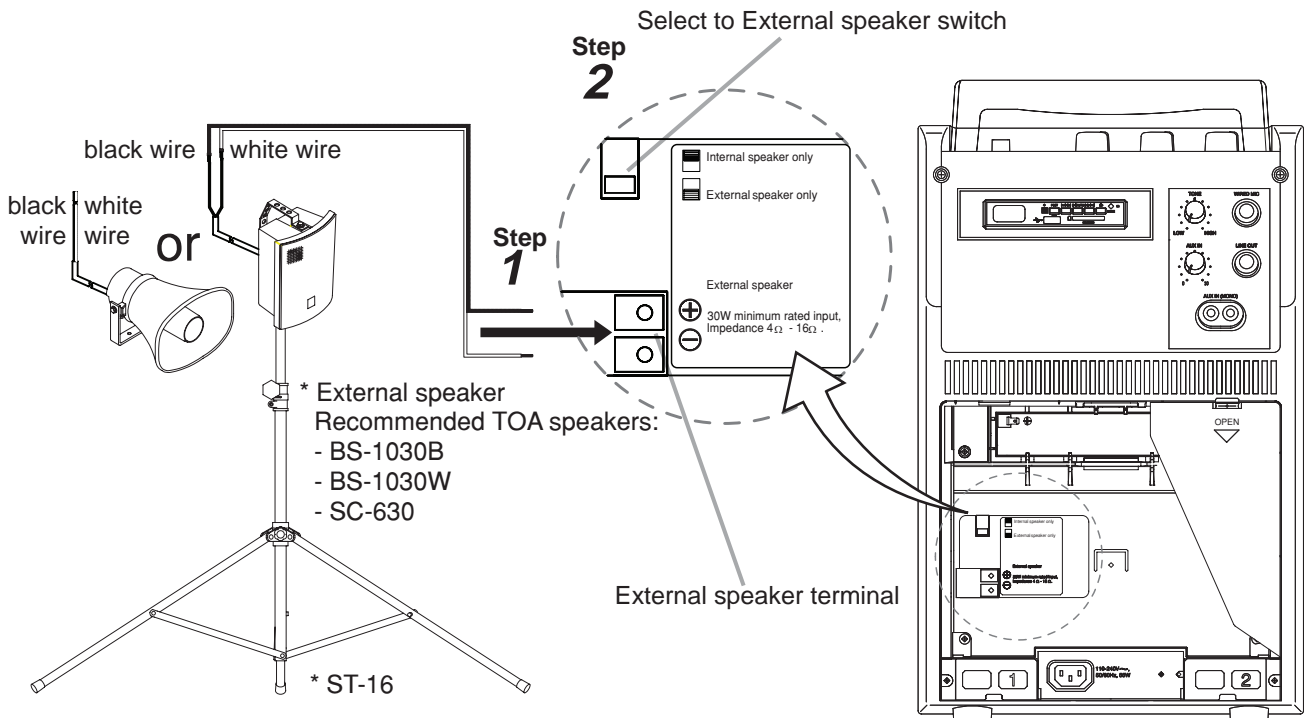

10.2. When Using an External CD Player

Step 1. Connect the CD player or other sound source line output to the unit's External Input terminal using a pin cable. Input sensitivity is -20 dB, 10 k Ω . (0 dB = 1 V)

Step 2. Adjust the volume with the External Input Volume control.

Note :

The External Input terminal is monaural. Even if the input signal is in stereo, it is played back in single-channel monaural.

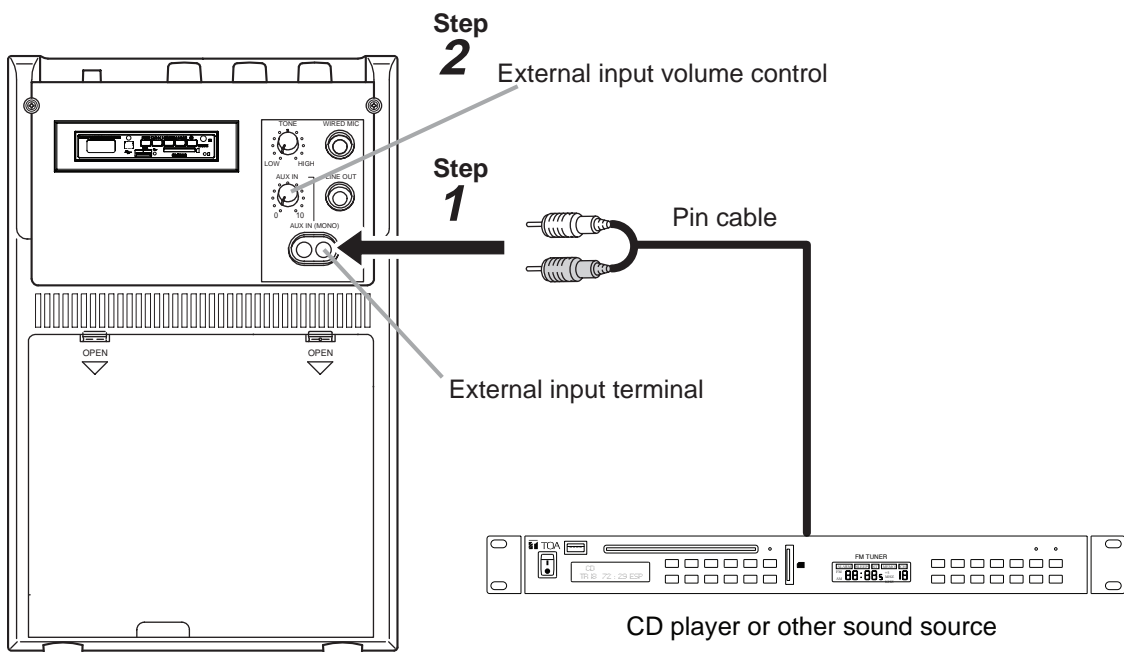

10.3. When Using an External Amplifier

Step 1. Connect the unit's External Line Output terminal to the external amplifier's AUX Input terminal or the other units Line Input terminal using a phone plug cable. Output sensitivity is 0 dB, 1 kΩ. (0 dB = 1 V)

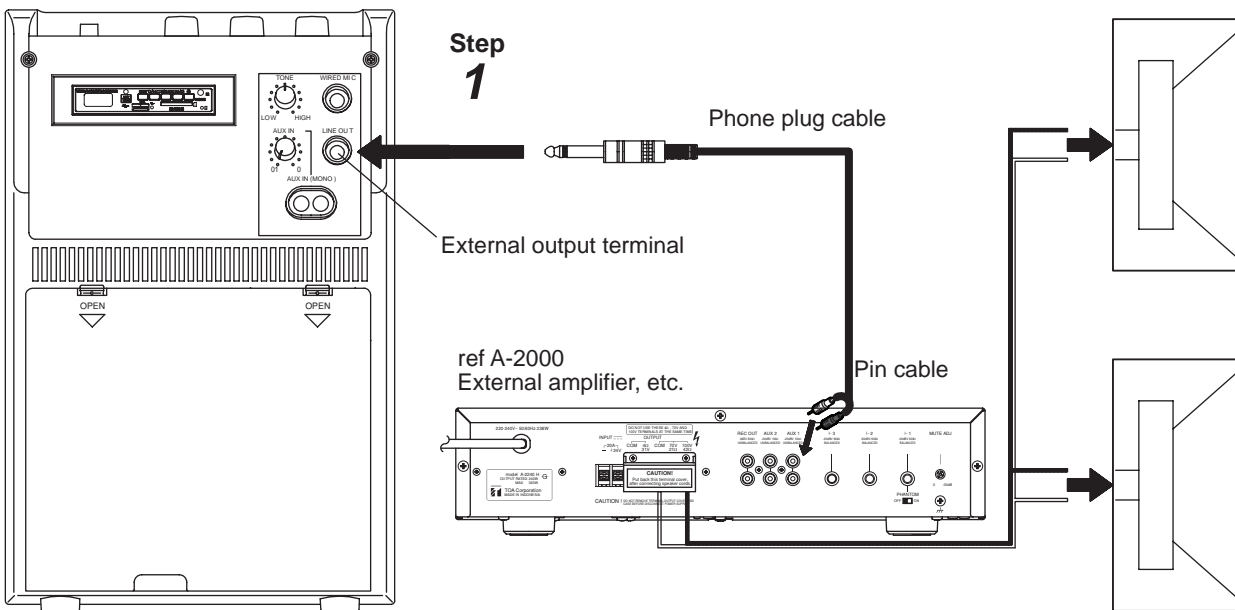

11. TROUBLESHOOTING

Symptom	Cause	Remedy	
The power indicator lamp does not light even when the power switch is set to the ON position. (Power is not supplied.)	[When operated on AC power] The power plug is not connected to an AC outlet.	Insert the power plug into the AC outlet.	
	[When operated on battery] Battery not inserted with correct polarity.	Reinstall the battery correctly.	
The low battery indicator does light.	[When operated on battery] Battery discharged.	Charge battery.	
No sound output.	The Internal or External switch is set to the External position.	Set the switch to the Internal speaker position.	
	The volume control is set to the "0" position	Rotate the volume control clockwise.	
Wireless Microphone	The Radio signal reception indicator lamp does not light. (No signal reception.)	The tuner unit is not installed.	Install the tuner unit.
		The wireless microphone's power switch is switched OFF.	Set the wireless microphone power switch to the ON position.
		The wireless microphone's batteries have lost their charge.	Replace the microphone's batteries with new ones.
		The wireless microphone's frequency setting (Channel) does not match the tuner unit's setting (Channel).	Set both the wireless microphone and the tuner unit to the same frequency (Channel).
	No sound output.	The volume control is set to the "0" position.	Rotate the Volume control knob clockwise.
USB/SD Card	The file can not be read.	Format file is not supported.	Replace the format to MP3 or WAV.
		USB / SD Card problem.	Replace USB / SD Card of the other / new.
	No sound output.	Setting MP3 unit volume in volume minimum position.	Push ◀ in MP3 from V 0 to V 1 ~ V 32 (as needed).
Bluetooth	Can no connection.	Connection has not been successful.	Reset and reconnected.
		Has been connected to the others first.	Wait for the connection to the other in non-enable.

12. SPECIFICATIONS

Model	WA-1830M-AS	WA-1830MB-AS
Power Source	100 – 240 V AC, 50/60 Hz	100 – 240 V AC, 50/60 Hz, DC : 12 V, 2.3 Ah (Rechargeable Battery)
Power Consumption	AC : 55 W (rated output)	
Rated Output	AC : 30 W; DC : 10 W	
Battery Life	–	Approx. 5 hrs continuous music
Battery Charging Time	–	Full charge 12 hours
Battery Type	Not Included	12 V, 2.3 Ah x 1 pcs Lead Acid Battery
Frequency Response	50 Hz - 15 kHz	
Distortion	Under 5 % (rated output)	
Input	Wired microphone : –45 dB*, 600 Ω, Unbalanced, 6.3 mm phone jack External Input : –20 dB*, 10 kΩ, Unbalanced, RCA jack	
Output	External speaker : 4 – 16 Ω / over 30 W of rated input External Output : 0 dB*, 1 kΩ, Unbalanced, 6.3 mm phone jack	
Other Feature	Internal or External speaker switch selection	
S/N Ratio	Over 60 dB (rated output)	
Antenna	Built-in	
Internal Speaker	2-way speaker system : 20 cm full-range speaker and tweeter	
MP3 Player	Extension type file is : MP3 file, WMA file, WAV file, AAC file, FLAC file. Max. supported storage size of the medium [stick] : 32 GB. (FAT16/FAT32) Source : USB, SD/MMC, BLUETOOTH, FM, REC, AUX. Signal from input can be record to SD/USB with format MP3 file. Please we do not guarantee that its support all kinds of USB/SD.	
Operation Temperature	–10 ⁰ C to +50 ⁰ C,	
Finish	ABS resin, Black	
Dimensions	298 (w) x 460 (h) x 200 (d) mm, (11.73" x 18.11" x 7.87")	
Weight	5.3 kg (11.68 lb)	6.2 kg (13.66 lb)

* 0 dB = 1 V

Note: The design and specifications are subject to change without notice for improvement.

• Accessories

Dust cover	1
Setting screwdriver	1
AC power cord (2 m)	1
Remote control MP3	1

• Optional Accessories

WTU-4800 Tuner Unit
TOA's WM-5000 series Wireless Microphone

