

CEILING MOUNT SPEAKERS

PC-668R-AS PC-668RC-AS

Thank you for purchasing TOA's Ceiling Mount Speaker.

Please carefully follow the instructions in this manual to ensure long, trouble-free use of your equipment.

1. SAFETY PRECAUTIONS

- Before installation or use, be sure to carefully read all the instructions in this section for correct and safe operation.
- Be sure to follow all the precautionary instructions in this section, which contain important warnings and/or cautions regarding safety.
- After reading, keep this manual handy for future reference.
- Do not use other methods than specified to mount the bracket. Extreme force is applied to the unit and the unit could fall off, possibly resulting in personal injuries.

WARNING

Indicates a potentially hazardous situation which, if mishandled, could result in death or serious personal injury.

CAUTION

Indicates a potentially hazardous situation which, if mishandled, could result in moderate or minor personal injury, and/or property damage.

- Install the unit only in a location that can structurally support the weight of the unit and the mounting bracket. Doing otherwise may result in the unit falling down and causing personal injury and/or property damage.
- Since the unit is designed for in-door use, do not install it outdoors. If installed outdoors, the aging of parts causes the unit to fall off, resulting in personal injury. Also, when it gets wet with rain, there is a danger of electric shock.
- Avoid touching the unit's sharp metal edge to prevent injury.
- To avoid electric shocks, be sure to switch off the amplifier's power when connecting speakers.
- Do not operate the unit for an extended period of time with the sound distorting. This is an indication of a malfunction, which in turn can cause heat to generate and result in a fire.

2. SPECIFICATIONS

Model No.	PC-668R-AS	PC-668RC-AS
Rated Input	15 W (100 V, 70 V line)	
Rated Impedance	100 V line: 670 Ω (15 W), 1 kΩ (10 W), 2 kΩ (5 W), 3.3 kΩ (3 W) 70 V line: 330 Ω (15 W), 670 Ω (7.5 W), 1 kΩ (5 W), 2 kΩ (2.5 W), 3.3 kΩ (1.5 W)	
Sensitivity (500 – 5,000 Hz, pink noise)	96 dB (1 W, 1 m)	
Frequency Response	65 – 20,000 Hz (at 20 dB below peak)	
Speaker Component	20 cm (8") double cone type	
Dimensions for Fixing Hole	ø250 ± 5 mm (ø9.84" ±0.2")	
Ceiling Thickness for Mounting	5 – 25 mm (0.2" – 0.98")	
Speaker Mounting Method	Spring clamp	
Input Connector	Not Applicable	Push-in connector
Finish	Baffle: polypropylene resin, white (RAL 9016 equivalent) Grille: Surface-treated steel plate net, white (RAL 9016 equivalent), paint	
Dimensions	ø280 x 90 (d) mm (ø11.02" x 3.54")	
Weight	0.96 kg (2.12 lb)	0.97 kg (2.14 lb)
Accessory	Paper pattern 1	

Note: The design and specifications are subject to change without notice for improvement.

3. GENERAL DESCRIPTION

Integrated with a resin panel and speaker frame, the PC-668R-AS and PC-668RC-AS are the ceiling mount speakers with a metal grille attached. They feature spring clamp mechanism for easy speaker mounting to the ceiling. The input impedance can be easily changed by changing the tap position of the transformer.

4. INSTALLATION

Step 1. Using the supplied paper pattern as a guide, open a mounting hole of the dimension specified below in the ceiling.

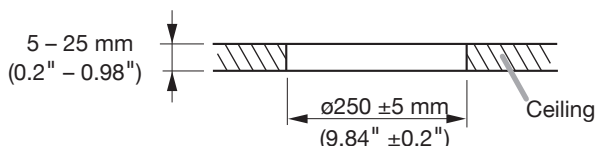

Step 2. Hook the speaker mounting spring into the mounting hole in the ceiling.

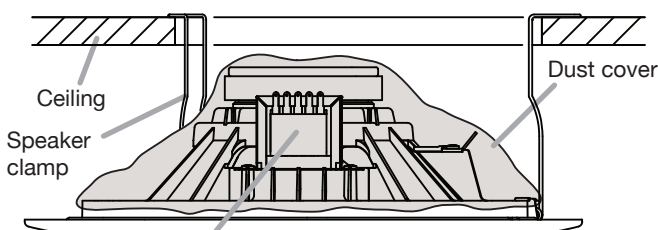

The figure 1

Step 3. Make wiring.

3.1.a. PC-668R-AS

Connect its HOT line to the black lead wire, and COM line to the white one. Such as the figure 2.

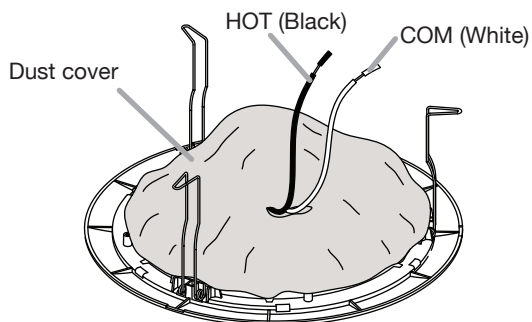

The figure 2

3.1.b. PC-668RC-AS

Insert the lead-in cables (cables from the amplifier) and lead-cut cables (cables to other speakers) into the input connector. Such as the figure 3.

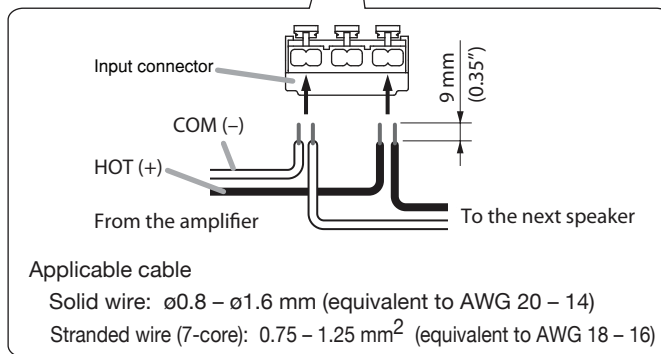
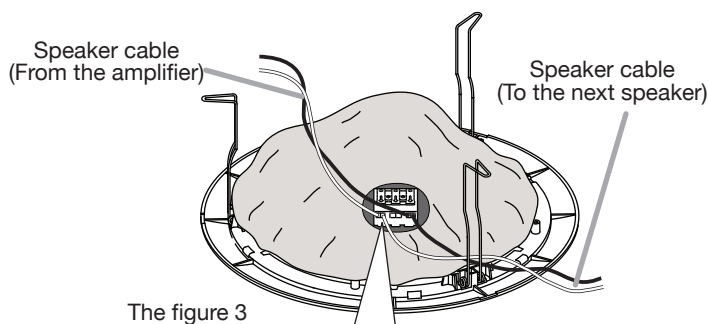

3-2. Change the input impedance as needed.

The speaker's input is factory-preset to 670 Ω . When changing the input impedance, detach the black wire connected to the matching transformer, and reinsert it into the desired input tap referring to the table below.

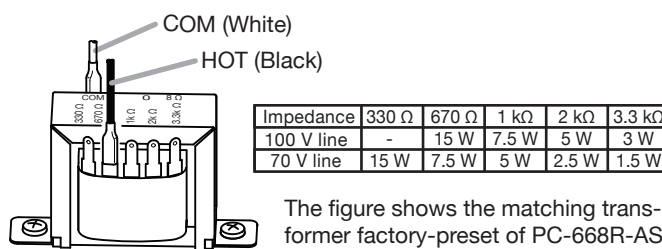

Step 4. Push the panel surface into the mounting hole.

5. WIRING DIAGRAMS

5.1. PC-668R-AS

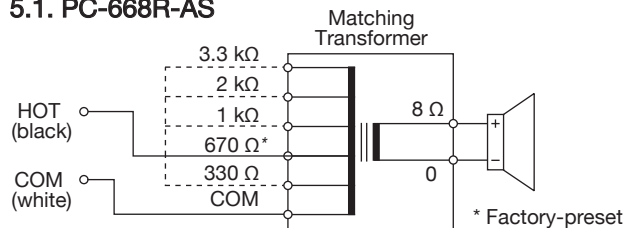

5.2. PC-668RC-AS

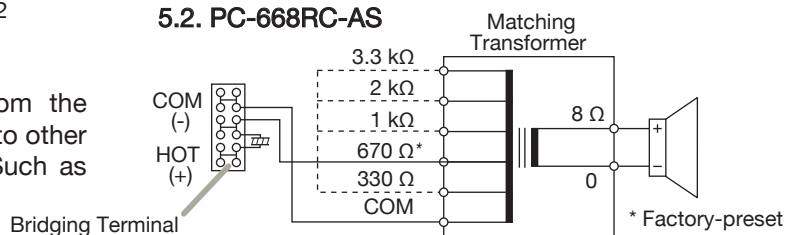

Traceability Information for Europe

Manufacturer:
 TOA Corporation
 7-2-1, Minatojima-Nakamachi, Chuo-ku, Kobe, Hyogo,
 Japan

Authorized representative:
 TOA Electronics Europe GmbH
 Suederstrasse 282, 20537 Hamburg,
 Germany